



Thermostatic expansion valve

T 2 / TE 2

Thermostatic expansion valves maintain a constant superheat level at the evaporator outlet

Description

Thermostatic expansion valves regulate the injection of refrigerant liquid into evaporators.

Injection is controlled by the refrigerant superheat.

Therefore, the valves are especially suitable for liquid injection in "dry" evaporators where the superheat at the evaporator outlet is proportional to the evaporator load.

Features & benefits

- Large temperature range
 - Equally applicable to freezing, refrigeration and air conditioning applications
- Interchangeable orifice assembly
 - Easy storage
 - Easy capacity matching
 - Better service
 - Easy cleaning and replacement of filter
- Rated capacities from 1 to 20.5 kW / 0.3 to 5.8 TR for R407C
- Can be supplied with MOP (Maximum Operating Pressure)
 - Protects the compressor motor against excessive evaporating pressure during normal operation
- Stainless steel bulb and Danfoss patented bulb strap
 - Fast and easy to install
 - Good temperature transfer from pipe to bulb
- Valves for special temperature ranges can be supplied
- Design protected

Ordering

Product code numbers

T 2 / TE 2 Thermostatic element with bulb strap

Figure: Flare x flare

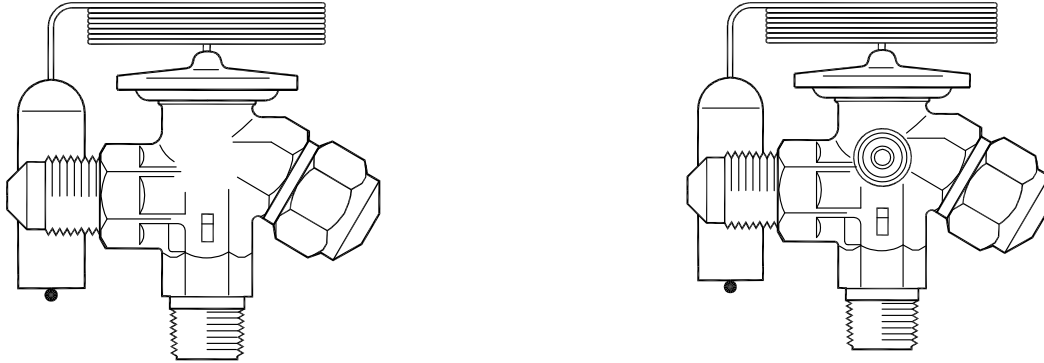

Capillary tube: 1.5 m

Range N = -40 – 10 °C

Range B = -60 – -25 °C

Range NM = -40 – -5 °C, MOP 0 °C

Range NL = -40 – -15 °C, MOP -10 °C

Table: Flare x flare

Refrigerant	Type	Range	MOP	Pressure equalization flare		Connection flare inlet x outlet		Code no. multi pack
		[°C]	[°C]	[in]	[mm]	[in]	[mm]	
R22 / R407C ⁽¹⁾	T 2	-40 – 10	–	–	–	3/8 x 1/2	10 x 12	068Z3206
	T 2	-40 – 10	15	–	–	3/8 x 1/2	10 x 12	068Z3208
	T 2	-40 – -5	0	–	–	3/8 x 1/2	10 x 12	068Z3224
	T 2	-40 – -15	-10	–	–	3/8 x 1/2	10 x 12	068Z3226
	T 2	-60 – -25	–	–	–	3/8 x 1/2	10 x 12	068Z3207
	T 2	-60 – -25	-20	–	–	3/8 x 1/2	10 x 12	068Z3228
	TE 2	-40 – 10	–	1/4	6	3/8 x 1/2	10 x 12	068Z3209
	TE 2	-40 – 10	15	1/4	6	3/8 x 1/2	10 x 12	068Z3211
	TE 2	-40 – -5	0	1/4	6	3/8 x 1/2	10 x 12	068Z3225
	TE 2	-40 – -15	-10	1/4	6	3/8 x 1/2	10 x 12	068Z3227
	TE 2	-60 – -25	–	1/4	6	3/8 x 1/2	10 x 12	068Z3210
TE 2	-60 – -25	-20	1/4	6	3/8 x 1/2	10 x 12	068Z3229	
R407C	T 2	-40 – 10	–	–	–	3/8 x 1/2	10 x 12	068Z3496
	T 2	-40 – 10	15	–	–	3/8 x 1/2	10 x 12	068Z3516
	TE 2	-40 – 10	–	1/4	6	3/8 x 1/2	10 x 12	068Z3501
	TE 2	-40 – 10	15	1/4	6	3/8 x 1/2	10 x 12	068Z3517
R134a / R513A	T 2	-40 – 10	–	–	–	3/8 x 1/2	10 x 12	068Z3346
	T 2	-40 – 10	15	–	–	3/8 x 1/2	10 x 12	068Z3347
	T 2	-40 – -5	0	–	–	3/8 x 1/2	10 x 12	068Z3393
	T 2	-40 – -15	-10	–	–	3/8 x 1/2	10 x 12	068Z3369
	TE 2	-40 – 10	–	1/4	6	3/8 x 1/2	10 x 12	068Z3348
	TE 2	-40 – 10	15	1/4	6	3/8 x 1/2	10 x 12	068Z3349
	TE 2	-40 – -5	0	1/4	6	3/8 x 1/2	10 x 12	068Z3392
TE 2	-40 – -15	-10	1/4	6	3/8 x 1/2	10 x 12	068Z3370	

R404A / R507	T 2	-40 - 10	-	-	-	$\frac{3}{8} \times \frac{1}{2}$	10 × 12	068Z3400
	T 2	-40 - 10	15	-	-	$\frac{3}{8} \times \frac{1}{2}$	10 × 12	068Z3402
	T 2	-40 - -5	0	-	-	$\frac{3}{8} \times \frac{1}{2}$	10 × 12	068Z3406
	T 2	-40 - -15	-10	-	-	$\frac{3}{8} \times \frac{1}{2}$	10 × 12	068Z3408
	T 2	-60 - -25	-	-	-	$\frac{3}{8} \times \frac{1}{2}$	10 × 12	068Z3401
	T 2	-60 - -25	-20	-	-	$\frac{3}{8} \times \frac{1}{2}$	10 × 12	068Z3410
	TE 2	-40 - 10	-	$\frac{1}{4}$	6	$\frac{3}{8} \times \frac{1}{2}$	10 × 12	068Z3403
	TE 2	-40 - 10	15	$\frac{1}{4}$	6	$\frac{3}{8} \times \frac{1}{2}$	10 × 12	068Z3405
	TE 2	-40 - -5	0	$\frac{1}{4}$	6	$\frac{3}{8} \times \frac{1}{2}$	10 × 12	068Z3407
	TE 2	-40 - -15	-10	$\frac{1}{4}$	6	$\frac{3}{8} \times \frac{1}{2}$	10 × 12	068Z3409
	TE 2	-60 - -25	-	$\frac{1}{4}$	6	$\frac{3}{8} \times \frac{1}{2}$	10 × 12	068Z3404
	TE 2	-60 - -25	-20	$\frac{1}{4}$	6	$\frac{3}{8} \times \frac{1}{2}$	10 × 12	068Z3411
R407F / R407A	T 2	-40 - 10	-	-	-	$\frac{3}{8} \times \frac{1}{2}$	10 × 12	068Z3715
	TE 2	-40 - 10	-	$\frac{1}{4}$	6	$\frac{3}{8} \times \frac{1}{2}$	10 × 12	068Z3714
R448A / R449A	T 2	-40 - 10	-	-	-	$\frac{3}{8} \times \frac{1}{2}$	10 × 12	068Z3727
	TE 2	-40 - 10	-	$\frac{1}{4}$	6	$\frac{3}{8} \times \frac{1}{2}$	10 × 12	068Z3728
	T 2	-40 - -15	-10	-	-	$\frac{3}{8} \times \frac{1}{2}$	10 × 12	068Z3673
	TE 2	-60 - -25	-20	$\frac{1}{4}$	6	$\frac{3}{8} \times \frac{1}{2}$	10 × 12	068Z3736
R454C	T 2	-40 - 10	-	-	-	$\frac{3}{8} \times \frac{1}{2}$	10 × 12	068Z7483
	TE 2	-40 - 10	-	$\frac{1}{4}$	6	$\frac{3}{8} \times \frac{1}{2}$	10 × 12	068Z7485
R455A	T 2	-40 - 10	-	-	-	$\frac{3}{8} \times \frac{1}{2}$	10 × 12	068Z7496
	TE 2	-40 - 10	-	$\frac{1}{4}$	6	$\frac{3}{8} \times \frac{1}{2}$	10 × 12	068Z7499
R454C / R455A	TE 2	-40 - 10	-	-	-	$\frac{3}{8} \times \frac{1}{2}$	10 × 12	068Z7506
R1234yf	T 2	-40 - 10	-	-	-	$\frac{3}{8} \times \frac{1}{2}$	10 × 12	068Z7487
	TE 2	-40 - 10	-	$\frac{1}{4}$	6	$\frac{3}{8} \times \frac{1}{2}$	10 × 12	068Z7489

⁽¹⁾ For R407C plants, please select valves from the dedicated R407C program

Figure: Flare x solder

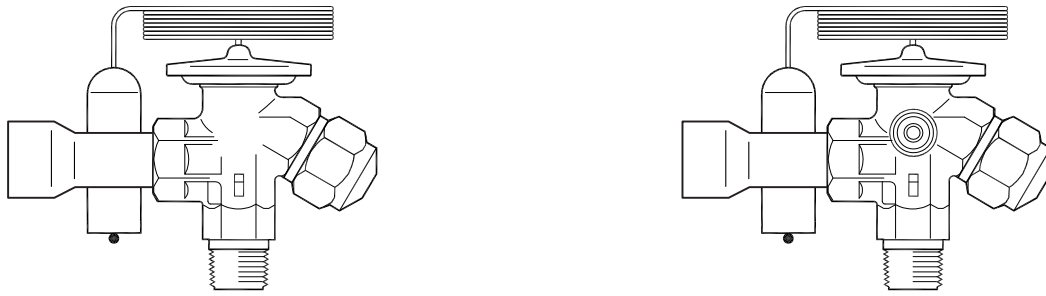

Capillary tube: 1.5 m

Range N = -40 – 10 °C

Range NL = -40 – -15 °C

Range B = -60 – -25 °C

Table: Flare x solder

Refrigerant	Type	Range	MOP	Pressure equalization flare		Connection flare inlet x solder outlet		Code no. multi pack
		[°C]	[°C]	[in]	[mm]	[in]	[mm]	
R22 / R407C ⁽¹⁾	T 2	-40 – 10	–	–	–	3/8 × 1/2	–	068Z3281
	T 2	-40 – 10	–	–	–	–	10 × 12	068Z3302
	T 2	-40 – 10	15	–	–	3/8 × 1/2	–	068Z3287
	T 2	-40 – 10	15	–	–	–	10 × 12	068Z3308
	T 2	-40 – -15	-10	–	–	–	10 × 12	068Z3366
	T 2	-60 – -25	–	–	–	3/8 × 1/2	–	068Z3357
	T 2	-60 – -25	–	–	–	–	10 × 12	068Z3361
	T 2	-60 – -25	-20	–	–	3/8 × 1/2	–	068Z3319
	TE 2	-40 – 10	–	1/4	–	3/8 × 1/2	–	068Z3284
	TE 2	-40 – 10	–	–	6	–	10 × 12	068Z3305
	TE 2	-40 – 10	15	1/4	–	3/8 × 1/2	–	068Z3290
	TE 2	-40 – 10	15	–	6	–	10 × 12	068Z3311
	TE 2	-40 – -15	-10	–	6	–	10 × 12	068Z3367
	TE 2	-60 – -25	–	1/4	–	3/8 × 1/2	–	068Z3359
	TE 2	-60 – -25	–	–	6	–	10 × 12	068Z3363
TE 2	-60 – -25	-20	1/4	–	3/8 × 1/2	–	068Z3320	
R407C	T 2	-40 – 10	–	–	–	–	10 × 12	068Z3502
	T 2	-40 – 10	15	–	–	3/8 × 1/2	–	068Z3329
	T 2	-40 – 10	15	–	–	–	10 × 12	068Z3514
	TE 2	-40 – 10	–	1/4	–	3/8 × 1/2	–	068Z3446
	TE 2	-40 – 10	–	–	6	–	10 × 12	068Z3503
	TE 2	-40 – 10	15	1/4	–	3/8 × 1/2	–	068Z3447
R134a / R513A	TE 2	-40 – 10	15	–	6	–	10 × 12	068Z3515
	T 2	-40 – 10	–	–	–	3/8 × 1/2	–	068Z3383
	T 2	-40 – 10	–	–	–	–	10 × 12	068Z3384
	T 2	-40 – 10	15	–	–	3/8 × 1/2	–	068Z3387
	T 2	-40 – 10	15	–	–	–	10 × 12	068Z3388
	TE 2	-40 – 10	–	1/4	–	3/8 × 1/2	–	068Z3385
	TE 2	-40 – 10	–	–	6	–	10 × 12	068Z3386
	TE 2	-40 – 10	15	1/4	–	3/8 × 1/2	–	068Z3389
TE 2	-40 – 10	15	–	6	–	10 × 12	068Z3390	

R404A / R507	T 2	-40 – 10	–	–	–	$\frac{3}{8} \times \frac{1}{2}$	–	068Z3414
	T 2	-40 – 10	–	–	–	–	10 × 12	068Z3435
	T 2	-40 – 10	15	–	–	$\frac{3}{8} \times \frac{1}{2}$	–	068Z3416
	T 2	-40 – 10	15	–	–	–	10 × 12	068Z3423
	T 2	-40 – -15	-10	–	–	$\frac{3}{8} \times \frac{1}{2}$	–	068Z3429
	T 2	-40 – -15	-10	–	–	–	10 × 12	068Z3436
	T 2	-60 – -25	–	–	–	$\frac{3}{8} \times \frac{1}{2}$	–	068Z3418
	T 2	-60 – -25	–	–	–	–	10 × 12	068Z3425
	T 2	-60 – -25	-20	–	–	$\frac{3}{8} \times \frac{1}{2}$	–	068Z3420
	T 2	-60 – -25	-20	–	–	–	10 × 12	068Z3427
	TE 2	-40 – 10	–	$\frac{1}{4}$	–	$\frac{3}{8} \times \frac{1}{2}$	–	068Z3415
	TE 2	-40 – 10	–	–	6	–	10 × 12	068Z3422
	TE 2	-40 – 10	15	–	6	–	10 × 12	068Z3424
	TE 2	-40 – 10	15	$\frac{1}{4}$	–	$\frac{3}{8} \times \frac{1}{2}$	–	068Z3417
	TE 2	-40 – -15	-10	$\frac{1}{4}$	–	$\frac{3}{8} \times \frac{1}{2}$	–	068Z3430
	TE 2	-40 – -15	-10	–	6	–	10 × 12	068Z3437
	TE 2	-60 – -25	–	$\frac{1}{4}$	–	$\frac{3}{8} \times \frac{1}{2}$	–	068Z3419
	TE 2	-60 – -25	–	–	6	–	10 × 12	068Z3426
	TE 2	-60 – -25	-20	$\frac{1}{4}$	–	$\frac{3}{8} \times \frac{1}{2}$	–	068Z3421
TE 2	-60 – -25	-20	–	6	–	10 × 12	068Z3428	
R407F / R407A	T 2	-40 – 10	–	–	–	$\frac{3}{8} \times \frac{1}{2}$	–	068Z3716
	TE 2	-40 – 10	–	$\frac{1}{4}$	–	$\frac{3}{8} \times \frac{1}{2}$	–	068Z3713
R448A / R449A	T 2	-40 – 10	–	–	–	$\frac{3}{8} \times \frac{1}{2}$	–	068Z3729
	TE 2	-40 – 10	–	$\frac{1}{4}$	–	$\frac{3}{8} \times \frac{1}{2}$	–	068Z3730
	T 2	-40 – -15	-10	–	–	$\frac{3}{8} \times \frac{1}{2}$	–	068Z3664
	T 2	-60 – -25	-20	–	–	$\frac{3}{8} \times \frac{1}{2}$	–	068Z3737
	TE 2	-40 – -15	-10	$\frac{1}{4}$	–	$\frac{3}{8} \times \frac{1}{2}$	–	068Z3665
	TE 2	-60 – -25	-20	$\frac{1}{4}$	–	$\frac{3}{8} \times \frac{1}{2}$	–	068Z3738
	T 2	-40 – -15	-10	–	–	–	10 × 12	068Z3674
	TE 2	-60 – -25	-20	–	6	–	10 × 12	068Z3672
R452A	T 2	-40 – 10	–	–	–	$\frac{3}{8} \times \frac{1}{2}$	–	068Z3806
	TE 2	-40 – 10	–	$\frac{1}{4}$	–	$\frac{3}{8} \times \frac{1}{2}$	–	068Z3807
	T 2	-40 – 10	–	–	–	–	10 × 12	068Z3808
	TE 2	-40 – 10	–	–	6	–	10 × 12	068Z3809
R454C	T 2	-40 – 10	–	–	–	$\frac{3}{8} \times \frac{1}{2}$	–	068Z7490
	T 2	-40 – 10	–	–	–	–	10 × 12	068Z7484
	TE 2	-40 – 10	–	$\frac{1}{4}$	–	$\frac{3}{8} \times \frac{1}{2}$	–	068Z7492
	TE 2	-40 – 10	–	–	6	–	10 × 12	068Z7486
R455A	T 2	-40 – 10	–	–	–	$\frac{3}{8} \times \frac{1}{2}$	–	068Z7494
	T 2	-40 – 10	–	–	–	–	10 × 12	068Z7498
	TE 2	-40 – 10	–	$\frac{1}{4}$	–	$\frac{3}{8} \times \frac{1}{2}$	–	068Z7501
	TE 2	-40 – 10	–	–	6	–	10 × 12	068Z7500
R454C / R455A	TE 2	-40 – 10	–	–	6	–	10 × 12	068Z7507
R1234yf	T 2	-40 – 10	–	–	–	$\frac{3}{8} \times \frac{1}{2}$	–	068Z7491
	T 2	-40 – 10	–	–	–	–	10 × 12	068Z7488
	TE 2	-40 – 10	–	$\frac{1}{4}$	–	$\frac{3}{8} \times \frac{1}{2}$	–	068Z7493
	TE 2	-40 – 10	–	–	6	–	10 × 12	068Z7495

⁽¹⁾ For R407C plants, please select valves from the dedicated R407C program

Flare connections

Figure: Flare connections

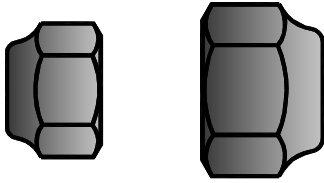

Table: Flare connections

Connection for copper tubing with outside diameter		Reducer for copper tubing with outside diameter		Code no.
[in]	[mm]	[in]	[mm]	
¼	6	–	–	011L1101
⅜	10	–	–	011L1135
½	12	–	–	011L1103
–	–	¼	6	011L1107

Example:

A TE 2 thermostatic expansion valve consists of two parts + flare nuts if required:

- 1 thermostatic element
- 1 orifice assembly and flare nuts

When ordering one thermostatic expansion valve, TE 2 with orifice 01, five code numbers are required:

- 1-off thermostatic element: 068Z3209
- 1-off orifice assembly: 01-068-2010
- 1-off ⅜ in flare nut: 011L1135
- 1-off ½ in flare nut: 011L1103
- 1-off ¼ in flare nut: 011L1101

Orifice assembly with filter

Figure: Orifice assembly with filter

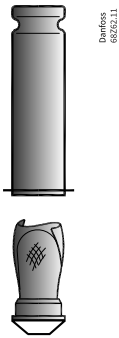

Table: Orifice assembly with filter

Orifice no.	Code no.
0X	068-2002
00	068-2003
01	068-2010
02	068-2015
03	068-2006
04	068-2007
05	068-2008
06	068-2009

Orifice assembly with filter for solder adaptor

Figure: Orifice assembly with filter for solder adaptor

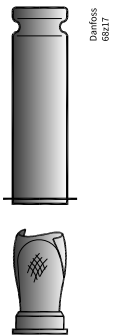

Table: Orifice assembly with filter for solder adaptor

Orifice no.	Code no.
0X	068-2089
00	068-2090
01	068-2091
02	068-2092
03	068-2093
04	068-2094
05	068-2095
06	068-2096

Filter

Figure: Filter type for industrial pack

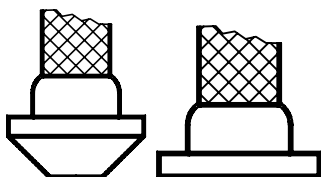

Table: Filter type for industrial pack

Filter type	Code no.
For flare connection	068-0003
For solder adaptor	068-0015

Table: Filter type for multi pack

Filter type	Code no.
For flare connection	068-0080
For solder adaptor	068-0081

The adaptor is for use with thermostatic expansion valves T 2 and TE 2. When the adaptor is fitted correctly it meets the sealing requirements of DS/EN ISO 14903: 2017. The flare orifice in T 2 and TE 2 can be used with a solder adaptor when the orifice filter is replaced with a specific filter intended for solder adaptors. Only in this way the sealing requirements of DS/EN ISO 14903: 2017 can be fulfilled. Solder adaptors for filter driers (FSA) must not be used on the T 2 inlet.

Solder adaptor

Figure: Solder adaptor

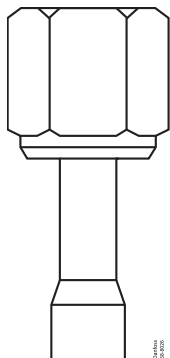

The adaptor is for use with thermostatic expansion valves T 2 and TE 2 with flare x solder connections. When the adaptor is fitted correctly it meets the sealing requirements of DIN 8964.

The adaptor offers the following advantages:

- The orifice assembly can be replaced.
- The filter can be cleaned or replaced.

When using the solder adapter, a special orifice assembly is required. Please use the following tables to select both the appropriate adapter and orifice assembly.

Only in this way the sealing requirements of DIN 8964 be fulfilled.

Solder adaptor for filter drier (FSA) must not be used in the T 2 inlet.

Table: Solder adaptor without orifice assembly and filter

Connection ODF solder	Code no.
¼ in	068-2062
6 mm	068-2063
¾ in	068-2060
10 mm	068-2061

Table: Filter for solder adaptor

Description	Code no.
Filter excl. orifice assembly	068-0015

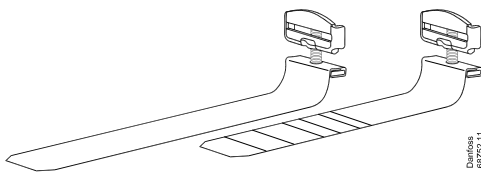
Figure: Bulb strap (Danfoss patented)

Each valve is delivered with a Danfoss patented bulb strap. Spares can be ordered.

Table: Bulb strap (Danfoss patented)

Description	Pack mode	Quantity / pack	Code no.
Accessory bag with short bulb strap I/45	I	45	068U3525
Accessory bag with long bulb strap I/45	I	45	068U3527
Accessory bag with short bulb strap M/25	M	25	068U3520
Accessory bag with long bulb strap M/45	M	45	068U3528

Functions

Figure: Functions

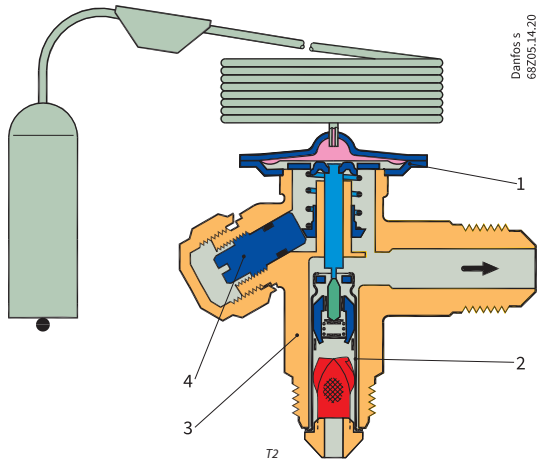

1	Thermostatic element
2	Interchangeable orifice assembly
3	Valve body
4	Superheat setting spindle (see instructions)

T 2 and TE 2 valves have an interchangeable orifice assembly.

The orifice assembly is suitable for all versions of valve body and refrigerants and in all evaporating temperature ranges.

The charge in the thermostatic element depends on the refrigerant and evaporating temperature range.

The valves are available with internal (T 2) or external (TE 2) pressure equalization.

External pressure equalization should always be used on systems with liquid distributors. The bulb gives fast and precise reaction to temperature changes in the evaporator. The bulb is fixed with a Danfoss patented bulb strap for quick, easy and reliable connection. The valves are able to withstand the effects that normally occur with hot gas defrosting.

To ensure long operating life, the valve cone and seat are made of a special alloy with particularly good wear qualities.

Product details

General data

Identification

Figure: Identification

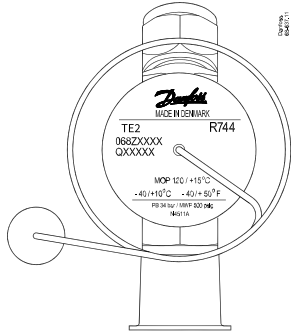

T 2	Internal equalization
TE 2	External equalization
N	Nordborg, Denmark (BE = Wuqing, China)
45	Week
11	2011
A	Monday

Production place and date N4511A

The thermostatic element has laser engraved data on top of the diaphragm. This engraving gives valve type (with code number), evaporating temperature range, MOP point, refrigerant, and max. working pressure PS/MWP.

Figure: Orifice assembly and filter for flare x flare version for T 2 and TE 2

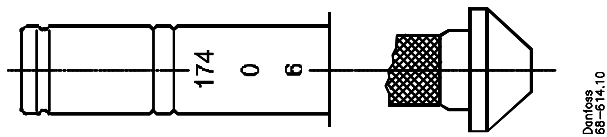

Orifice assembly for T 2 and TE 2

The orifice assembly is marked with the orifice size (e.g. 06) and week stamp + last number in the year (e.g. 174). The orifice assembly number is also given on the lid of its plastic container.

Figure: Capillary tube label for T 2 and TE 2



Capillary tube label for T 2 and TE 2

The label gives the orifice size (04) and consists of the lid of the orifice assembly plastic container. It can easily be fastened around the expansion valve capillary tube to clearly identify the valve size.

Capacity

Valve selection based on capacity calculation

As for extended capacity calculations and valve selection based on capacities and refrigerants, please refer to Coolselector®2. Rated and extended capacities are calculated with the Coolselector®2 calculation engine to ARI standards with the ASEREP equations based on laboratory measurements of selected valves.

How to select a valve

Example:

- Refrigerant = R407C
- Q (capacity) = 1.1 kW
- T_{cond} (condensing temperature) = 25 °C
- T_{evap} (evaporator temperature) = -30 °C
- T_{sub} (subcooling temperature) = 2 K
- D_{pd} (distributer pressure drop) = 1 bar
- Q (capacity) = 1.1 kW
- f_{sub} (subcooling correction factor) = 0.98
- f_{p} (distribution correction factor) = 0.96

$$\frac{Q}{f_{\text{sub}} \times f_{\text{p}}} = \text{selected capacity}$$

$$\frac{1.1}{0.98 \times 0.96} = 1.17 \text{ kW}$$

The selection will be: TE 2 orifice 00 (1.21 kW > 1.17 kW)

Table: Capacity in kW, range N -40 – 10 °C. Opening superheat sh= 6 K

Valve type	Orifice no.	Cond. temp. [°C]	Evaporating [°C]			
			-40	-30	-20	-10
T 2 / TE 2	0X	25	0.76	0.83	0.88	0.9
T 2 / TE 2	00		0.99	1.21	1.42	1.6
T 2 / TE 2	1		1.41	1.8	2.27	2.77

Table: Subcooling correction factor (f_{sub})

Subcooling [K]	2	4	10	15
Correction factor	0.98	1	1.07	1.12

Table: Distributer correction factor (f_{p}) *

Pressure drop [bar]		Evaporating [°C]			
		-40	-35	-30	-25
Pressure drop	0	1	1	1	1
	1	0.96	0.96	0.96	0.96
	1.5	0.94	0.94	0.94	0.94
	2	0.92	0.92	0.92	0.92

* Calculated at 32 °C condensing temperature

Table: Range N, -40 to 50 °F

Orifice no.	Rated capacity in tons (TR)											
	R22	R407C	R134a	R513A	R404A / R507	R407A	R407F	R448A	R449A	R454C	R455A	R1234yf
0X	0.25	0.26	0.19	0.16	0.18	0.25	0.28	0.26	0.25	0.22	0.24	0.14
0	0.51	0.51	0.34	0.29	0.37	0.49	0.56	0.51	0.49	0.42	0.47	0.25
1	1	1	0.59	0.51	0.75	1	1.1	1	0.97	0.79	0.93	0.43
2	1.3	1.4	0.73	0.62	1	1.3	1.5	1.4	1.3	1	1.3	0.53
3	2.3	2.3	1.2	1	1.8	2.3	2.6	2.3	2.3	1.8	2.2	0.88
4	3.4	3.5	1.8	1.5	2.8	3.5	4.1	3.6	3.5	2.6	3.3	1.3
5	4.8	4.7	2.4	2	3.7	4.6	5.4	4.6	4.5	3.4	4.2	1.7
6	5.6	5.6	2.9	2.5	4.4	5.6	6.5	5.7	5.5	4.2	5.2	2.1

The rated capacity is based on:

- Evaporating temperature $t_e = 40$ °F
- Condensing temperature $t_c = 100$ °F
- Refrigerant temperature ahead of valve $t_1 = 98$ °F

Table: Range N, -40 to 10 °C

Orifice no.	Rated capacity in kW											
	R22	R407C	R134a	R513A	R404A / R507	R407A	R407F	R448A	R449A	R454C	R455A	R1234yf
0X	0.9	0.92	0.68	0.58	0.64	0.88	1	0.9	0.88	0.77	0.86	0.49
0	1.8	1.8	1.2	1	1.3	1.7	2	1.8	1.7	1.5	1.7	0.87
1	3.5	3.5	2.1	1.8	2.6	3.4	3.9	3.5	3.4	2.8	3.3	1.5
2	4.7	4.8	2.6	2.2	3.7	4.7	5.4	4.8	4.6	3.6	4.4	1.8
3	8	8.1	4.3	3.7	6.3	8	9.2	8.1	7.9	6.2	7.6	3.1
4	12.1	12.4	6.4	5.4	9.9	12.4	14.3	12.6	12.1	9.3	11.5	4.6
5	16.7	16.5	8.4	6.9	13	16.3	19	16.3	15.7	11.8	14.7	5.9
6	19.7	19.7	10.1	8.6	15.5	19.6	22.9	19.8	19.1	14.8	18.3	7.3

The rated capacity is based on:

- Evaporating temperature $t_e = 4.4$ °C
- Condensing temperature $t_c = 38$ °C
- Refrigerant temperature ahead of valve $t_1 = 37$ °C

Pressure and temperature data

Max. temperature

Bulb, when valve is installed: 100 °C

Bulb, element not mounted: 60 °C

Min. temperature

T2 – TE2: -60 °C

Max. test pressure

PT = 38 bar

Max. working pressure

PS/MWP = 34 bar

Table: Technical data

Refrigerant	Range N -40 – 10 °C	Range NM -40 – -5 °C	Range NL -40 – -15 °C	Range B -60 – -25 °C
	MOP-point in evaporating temperature t_e and evaporating pressure p_e ⁽¹⁾			
	15 °C / 60 °F	0 °C / 32 °F	-10 °C / 15 °F	-20 °C / -4 °F
	[psig / bar (abs)]	[psig / bar (abs)]	[psig / bar (abs)]	[psig / bar (abs)]
R22	100 / 6.9	60 / 4.0	35 / 2.4	20 / 1.4
R407C	95 / 6.6	–	–	–
R134a	55 / 3.8	30 / 2.0	15 / 1.0	–
R404A / R507	120 / 8.3	75 / 5.2	50 / 3.4	30 / 2.1

⁽¹⁾ p_e in bar gauge

Superheat

- SS = Static Superheat
- OS = Opening Superheat
- SH = SS + OS = Total superheat
- Q_{nom} = Rated capacity
- Q_{max} = Maximum capacity

Static superheat (SS) can be adjusted with setting spindle.

Standard superheat setting (SS) is 4 K for all standard valves.

The opening superheat (OS) is 6 K from when opening begins to where the valve gives its rated capacity Q_{nom} .

Example

Static superheat (SS) = 5 K

Opening superheat (OS) = 6 K

Total superheat (SH) = 5 + 6 = 11 K

Dimensions

Figure: Flare x flare

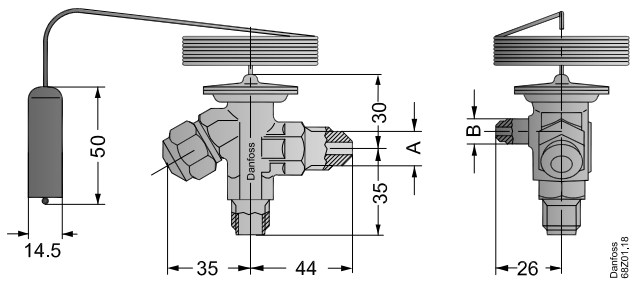
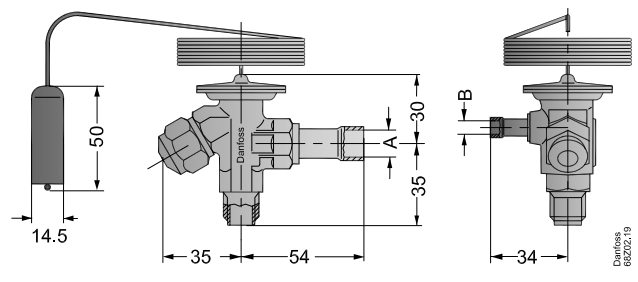

Figure: Flare x solder



Note: All dimensions are in mm

Table: Dimensions and weights

	Outlet	Equalization	Weight
	A	B	[kg / lb]
Flare x flare	1/2" flare	1/4" flare	0.3 / 0.7
Flare x solder	1/2" solder 12 mm solder	1/4" solder 6 mm solder	0.3 / 0.7

Figure: Solder adaptor

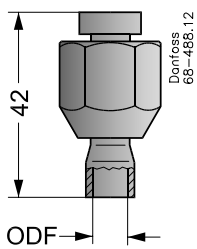

Table: Solder adaptor

Solder ODF		Weight
[in]	[mm]	[kg / lb]
1/4	6	0.05 / 0.11
3/8	10	0.05 / 0.11

Certificates, declarations and approvals

The list contains all certificates, declarations, and approvals for this product type. Individual code number may have some or all of these approvals, and certain local approvals may not appear on the list.

When you click on the link you will be directed to the latest version of the 'Declaration of Conformity'. Products developed and sold before this date of issue conform to the directives/standards in force at the time of their sale.

Approval type	Title	Certification body	Approval topic
Export Control Declaration	T2, TE 2 valves, adaptor, orifice	Danfoss	
EU Declaration	Danfoss EU 068U9904.03	Danfoss	EU RoHS
Manufacturer's Declaration	Danfoss MD 067R1068.AG	Danfoss	PED, Pressure
Manufacturer's Declaration	Danfoss MD 068U9615.13	Danfoss	PED, Pressure, EU RoHS, ATEX, Explosive
UA Declaration	Danfoss UA 2023-01-10 Valves PL01 PL40	Danfoss	PED, Pressure
Manufacturer's Declaration	Danfoss MD 033F4006 AC	Danfoss	China RoHS
Manufacturer's Declaration	Danfoss MD 068U9616.03	Danfoss	China RoHS
Pressure Safety Certificate	LLC CDC EURO-TYSK UA.TR.089.1015.02-22	LLC CDC EURO TYSK - Ukraine	PED, Pressure

Contact details

Online support

Danfoss offers a wide range of support along with our products, including digital information, software, mobile apps and expert guidance. See the possibilities below.



The Danfoss Design center

Discover the Design Center, our advanced digital platform that streamlines product selection. With integrated tools and enhanced type pages, it's simpler than ever to access product information and documentation, and to select the right products. Check the availability of Danfoss products at partner locations and enjoy seamless transitions from selection to purchase with our basket-to-basket functionality. Whether you're buying from our distributors or directly from the Product Store, the Design Center simplifies your experience. Learn more at: designcenter.danfoss.com.



The Danfoss product store

The Danfoss Product Store is a one-stop shop available 24/7 for our customers, no matter where you are in the world or what area of industry you work in. Browse our catalog, check product details and documentation, view your prices and product availability, and quickly finalize your purchase. Start browsing at: store.danfoss.com.



Danfoss Partner Portal/Product Data tool

Designed to support you with easy access to product data extracts, essential resources, tools, and information. The Partner Portal provides a centralized hub for product documentation, training materials, marketing assets, and technical support, ensuring you have everything you need to succeed and grow your business with Danfoss. The Partner Portal is available 24/7 at: partner.danfoss.com and is ready to support your business.



Find technical documentation

Find technical documentation you need to get your project up running. Get direct access to our official collection of data sheets, certificates and declarations, manuals and guides, 3D models and drawings, case stories, brochures, and much more. Start searching now at: documentation.danfoss.com.



Danfoss Learning

Danfoss Learning is a free online learning platform. It features courses and materials specifically designed to help engineers, installers, service technicians, and wholesalers better understand the products, applications industry topics, and trends that will help you do your job better. Find your local Danfoss website here: learning.danfoss.com.



Get local information and support

Local Danfoss websites are the main sources for help and information about our company and products. Find product availability, get the latest regional news, or connect with a nearby expert - all in your own language. Find your local Danfoss website here: danfoss.com.

Danfoss A/S

Climate Solutions . danfoss.com . +45 7488 2222

Any information, including, but not limited to information on selection of product, its application or use, product design, weight, dimensions, capacity or any other technical data in product manuals, catalogues description, advertisements, etc. and whether made available in writing, orally, electronically, online or via download, shall be considered informative, and is only binding if and to the extent, explicit reference is made in a quotation or order confirmation. Danfoss cannot accept any responsibility for possible errors in catalogues, brochures, videos and other material. Danfoss reserves the right to alter its products without notice. This also applies to products ordered but not delivered provided that such alterations can be made without changes to form, fit or function of the products. All trademarks in this material are property of Danfoss A/S or Danfoss group companies. Danfoss and the Danfoss logo are trademarks of Danfoss A/S. All rights reserved.
